

# MAX8847Y/MAX8847Z

## High-Performance Negative Charge Pump for 6 White LEDs in 3mm x 3mm Thin QFN

### General Description

The MAX8847Y/MAX8847Z negative charge pumps drive up to 6 white LEDs with regulated constant current for display backlight applications. By utilizing an inverting charge pump and extremely low-dropout adaptive current regulators, these ICs achieve very high efficiency over the full 1-cell Li+ battery voltage range even with large LED forward voltage mismatch. The 1MHz fixed-frequency switching allows for tiny external components. The regulation scheme is optimized to ensure low EMI and low input ripple. The MAX8847Y/MAX8847Z include thermal shutdown, open- and short-circuit protection.

The MAX8847Y/MAX8847Z support independent LED on/off and dimming control. The MAX8847Z has PWM dimming control for LED1–LED6. The MAX8847Y has PWM dimming control for LED1–LED4 and serial-pulse dimming control for LED5 and LED6. The serial-pulse dimming ranges are pseudo-logarithmic from 24mA to 0.1mA and off in 32 steps. All devices include a temperature derating function to safely allow bright 24mA full-scale output current while automatically reducing current gradually to protect LEDs at high ambient temperatures above +60°C.

The MAX8847Y/MAX8847Z are available in 16-pin, 3mm x 3mm thin QFN packages.

### Applications

White LED Backlighting  
Cellular Phones  
PDAs, Digital Cameras, and Camcorders

### Ordering Information

PART	DIMMING	PIN-PACKAGE	TOP MARK
MAX8847YETE+T	Serial pulse/ PWM	16 Thin QFN-EP*	AHQ
MAX8847ZETE+T	PWM	16 Thin QFN-EP*	AHP

**Note:** All devices are specified over the -40°C to +85°C extended temperature range.

+Denotes a lead(Pb)-free/RoHS-compliant package.

\*EP = Exposed pad.

### Features

- ◆ Negative 1x/1.5x Charge Pump
- ◆ Adaptive Current Regulators
- ◆ Independent Voltage Supply for Each LED
- ◆ 24mA to 0.1mA Serial-Pulse Dimming (MAX8847Y)
- ◆ 24mA to 0mA PWM Dimming (MAX8847Z)
- ◆ 2% (max) LED Current Accuracy, 1% (typ) Matching
- ◆ Low 120µA Quiescent Current
- ◆ Low 0.4µA Shutdown Current
- ◆ Inrush Current Limit
- ◆ Temperature Derating Function
- ◆ 16-Pin, 3mm x 3mm Thin QFN Packages

### Typical Operating Circuit

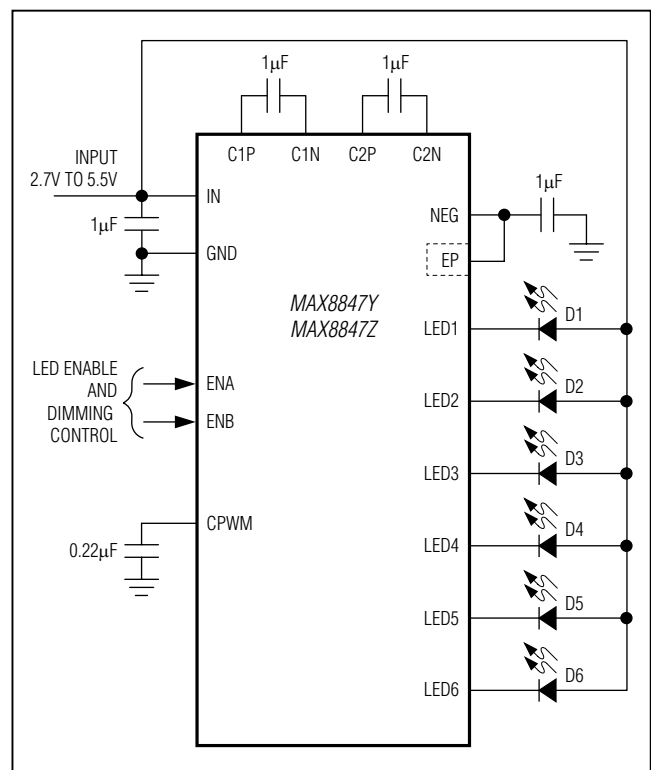

# MAX8847Y/MAX8847Z

## High-Performance Negative Charge Pump for 6 White LEDs in 3mm x 3mm Thin QFN

### ABSOLUTE MAXIMUM RATINGS

IN to GND .....	-0.3V to +6.0V	Junction-to-Case Thermal Resistance ( $\theta_{JC}$ ) (Note 1).....	10°C/W
IN to NEG .....	-0.3V to +6.0V	Junction-to-Ambient Thermal Resistance ( $\theta_{JA}$ ) (Note 1)	
NEG, C2N to GND .....	-6V to +0.3V	Multilayer PCB.....	48°C/W
C1P, C2P, CPWM, ENA, ENB to GND .....	-0.3V to ( $V_{IN} + 0.3V$ )	Operating Temperature Range .....	-40°C to +85°C
C2P to C1N .....	-0.3V to ( $V_{IN} + 0.3V$ )	Junction Temperature .....	+150°C
LED_, C1N, C2N, ENA, ENB to NEG .....	-0.3V to ( $V_{IN} + 0.3V$ )	Storage Temperature Range.....	-65°C to +150°C
Continuous Power Dissipation ( $T_A = +70^\circ\text{C}$ )		Lead Temperature (soldering, 10s) .....	+300°C
16-Pin Thin QFN Multilayer PCB		Soldering Temperature (reflow) .....	+260°C
(derate 20.8mW/°C above +70°C).....	1666.7mW		

**Note 1:** Package thermal resistances were obtained using the method described in JEDEC specification JESD51-7, using a four-layer board. For detailed information on package thermal considerations, refer to [www.maximintegrated.com/thermal-tutorial](http://www.maximintegrated.com/thermal-tutorial).

Stresses beyond those listed under "Absolute Maximum Ratings" may cause permanent damage to the device. These are stress ratings only, and functional operation of the device at these or any other conditions beyond those indicated in the operational sections of the specifications is not implied. Exposure to absolute maximum rating conditions for extended periods may affect device reliability.

### ELECTRICAL CHARACTERISTICS

( $V_{IN} = 3.6V$ ,  $V_{GND} = 0V$ ,  $T_A = -40^\circ\text{C}$  to  $+85^\circ\text{C}$ , unless otherwise noted. Typical values are at  $T_A = +25^\circ\text{C}$ .) (Note 2)

PARAMETER	CONDITIONS	MIN	TYP	MAX	UNITS	
IN Operating Voltage		2.7		5.5	V	
Undervoltage Lockout (UVLO) Threshold	$V_{IN}$ rising	2.35	2.45	2.55	V	
Undervoltage Lockout Hysteresis			100		mV	
IN Shutdown Supply Current	$V_{EN\_} = 0V$ , all outputs off		$T_A = +25^\circ\text{C}$ $T_A = +85^\circ\text{C}$	0.4 2.5	$\mu\text{A}$	
IN Operating Supply Current	Charge pump inactive, 2 LEDs enabled at 0.1mA setting		120	150	$\mu\text{A}$	
	Charge pump active, 1MHz switching, all LEDs enabled at 0.1mA setting		1.6		mA	
Thermal Shutdown Threshold			+160		°C	
Thermal Shutdown Hysteresis			20		°C	
<b>PWM DIMMING CONTROL</b>						
PWM Low-Level Input				0.4	V	
PWM High-Level Input		1.4			V	
EN_ PWM Input Signal Frequency Range	$C_{CPWM} = 0.22\mu\text{F}$	0.2		200	kHz	
PWM Dimming Filter Corner Frequency	$C_{CPWM} = 0.22\mu\text{F}$		2		Hz	
Current Dimming Range	Duty cycle = 0 to 100%	0		24	mA	
PWM Dimming Resolution	$1\% \leq \text{duty cycle} \leq 100\%$		0.24		mA/%	
<b>SERIAL-PULSE LOGIC (MAX8847Y LED5 and LED6 only)</b>						
EN_ Logic Input High Voltage		1.4			V	
EN_ Logic Input Low Voltage				0.4	V	
EN_ Logic-Input Current	$V_{IL} = 0V$ or $V_{IH} = 5.5V$	$T_A = +25^\circ\text{C}$	-1	0.01	+1	$\mu\text{A}$
		$T_A = +85^\circ\text{C}$		0.1		

# MAX8847Y/MAX8847Z

## High-Performance Negative Charge Pump for 6 White LEDs in 3mm x 3mm Thin QFN

### ELECTRICAL CHARACTERISTICS (continued)

( $V_{IN} = 3.6V$ ,  $V_{GND} = 0V$ ,  $T_A = -40^{\circ}C$  to  $+85^{\circ}C$ , unless otherwise noted. Typical values are at  $T_A = +25^{\circ}C$ .) (Note 2)

PARAMETER	CONDITIONS	MIN	TYP	MAX	UNITS	
EN_ Low Shutdown Delay $t_{SHDN}$		5	8		ms	
EN_ $t_{LO}$	See Figure 2	1		500	$\mu s$	
EN_ $t_{HI}$	See Figure 2	1			$\mu s$	
Initial EN_ $t_{INIT}$	See Figure 2, first EN_ high pulse	120			$\mu s$	
<b>CHARGE PUMP</b>						
Switching Frequency			1		MHz	
Soft-Start Time			0.5		ms	
Output Regulation Voltage	$V_{IN} - V_{NEG}$	4.3	5		V	
Open-Loop NEG Output Resistance	$(V_{NEG} - 0.5 \times V_{IN})/I_{NEG}$		2	4	$\Omega$	
NEG Shutdown Discharge Resistance	$V_{EN\_} = 0V$ , all outputs off		10		$k\Omega$	
<b>LED1-LED6 CURRENT REGULATOR</b>						
Current Setting Range	Serial-pulse interface or PWM	0.1		24.0	mA	
LED_ Current Accuracy	$V_{LED\_} = 0.5V$ for charge pump inactive, $V_{LED\_} = -0.9V$ , $V_{NEG\_} = -1.4V$	24mA setting, $T_A = +25^{\circ}C$	-2	$\pm 1$	+2	%
		24mA setting, $T_A = -40^{\circ}C$ to derating function start temperature (Note 3)	-5		+5	
		1.6mA setting, $T_A = +25^{\circ}C$		$\pm 5$		
Derating Function Start Temperature			+60		$^{\circ}C$	
Derating Function Slope	From derating function start temperature		-2.5		$\%/^{\circ}C$	
LED_ Dropout Voltage (Note 4)	Charge pump inactive, 24mA setting	$T_A = +25^{\circ}C$		85	125	mV
		$T_A = +85^{\circ}C$		95		
	Charge pump active, 24mA setting	$T_A = +25^{\circ}C$		110		
		$T_A = +85^{\circ}C$		124		
LED_ Current Regulator Switchover Threshold (Inactive to Active)	$V_{LED\_}$ falling	135	150	165	mV	
LED_ Current Regulator Switchover Hysteresis			100		mV	
LED_ Leakage in Shutdown	All LEDs off	$T_A = +25^{\circ}C$	0.01	5	$\mu A$	
		$T_A = +85^{\circ}C$	0.1			

**Note 2:** Limits are 100% production tested at  $T_A = +25^{\circ}C$ . Limits over the operating temperature range are guaranteed by design.

**Note 3:** Guaranteed by design. Not production tested.

**Note 4:** LED dropout voltage is defined as the LED\_ to GND voltage at which current into LED\_ drops 10% from the value at  $V_{LED\_} = 0.5V$ .

# MAX8847Y/MAX8847Z

## High-Performance Negative Charge Pump for 6 White LEDs in 3mm x 3mm Thin QFN

### Typical Operating Characteristics

( $V_{IN} = 3.6V$ ,  $V_{EN\_} = V_{IN}$ , circuit of Figure 1,  $T_A = +25^\circ C$ , unless otherwise noted.)

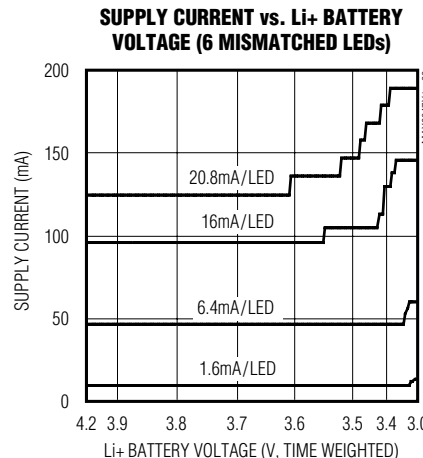
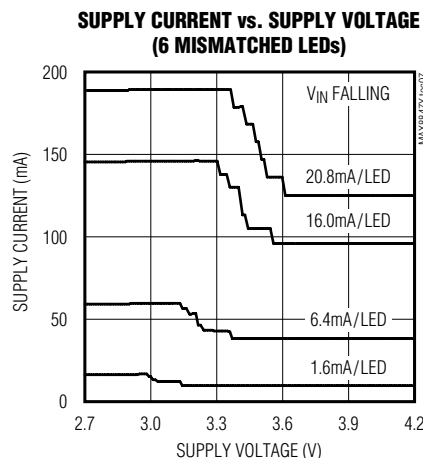
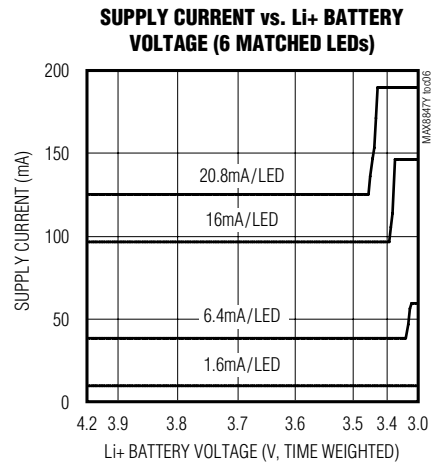
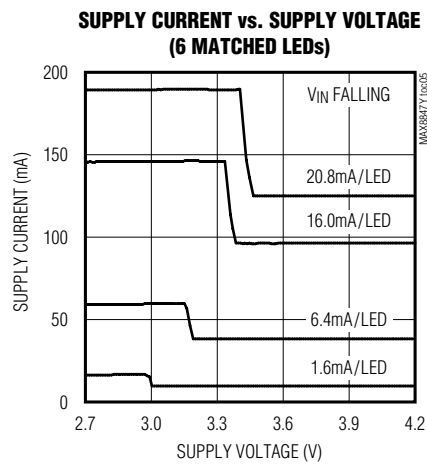
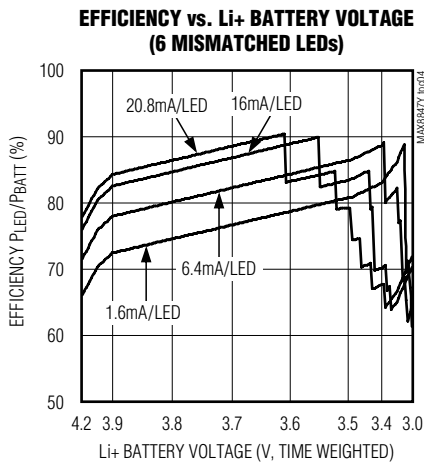
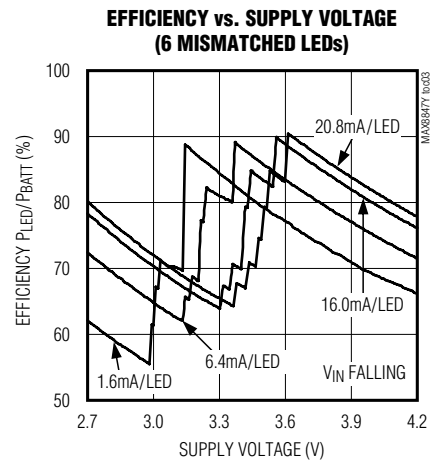
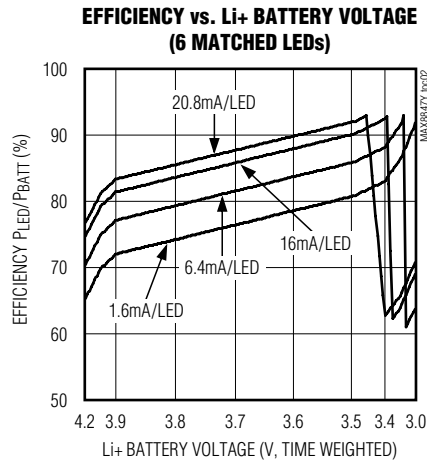
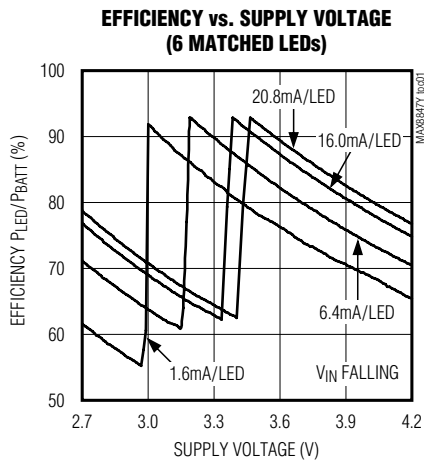

# MAX8847Y/MAX8847Z

## High-Performance Negative Charge Pump for 6 White LEDs in 3mm x 3mm Thin QFN

### Typical Operating Characteristics (continued)

( $V_{IN} = 3.6V$ ,  $V_{EN\_} = V_{IN}$ , circuit of Figure 1,  $T_A = +25^\circ C$ , unless otherwise noted.)

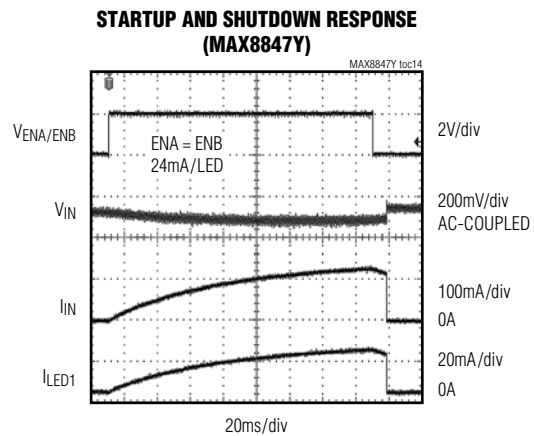
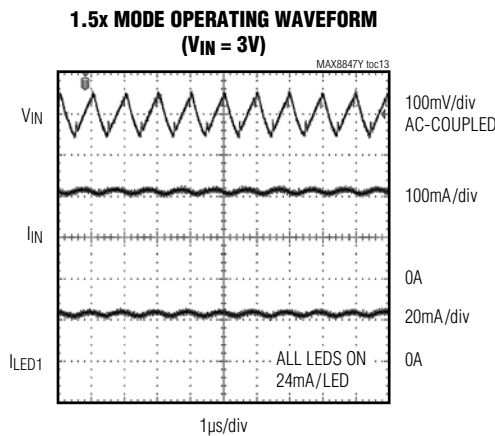
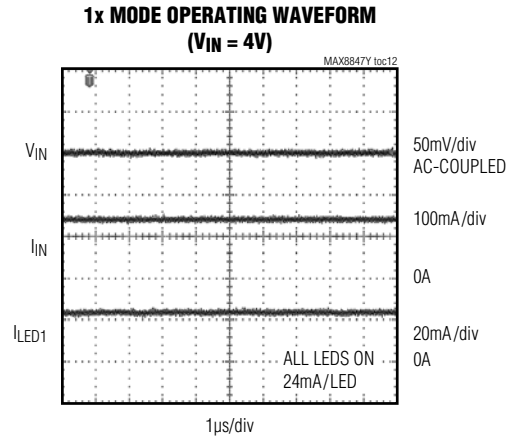
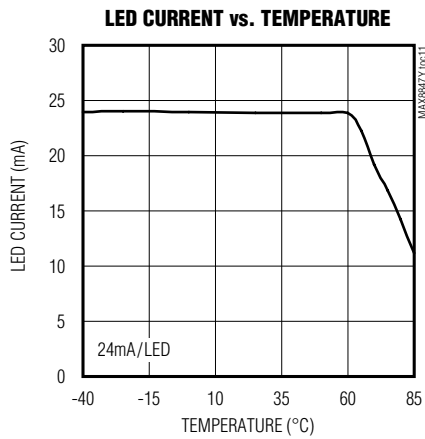
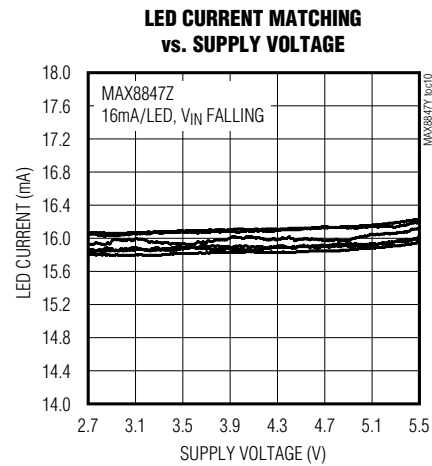
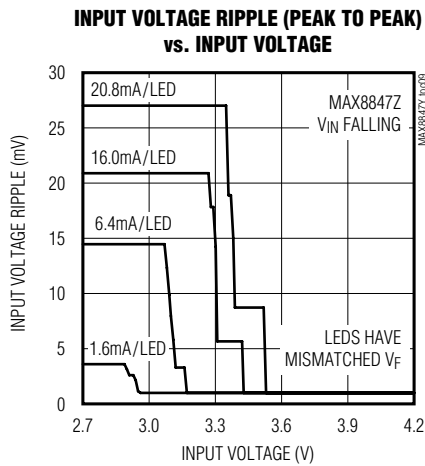

# MAX8847Y/MAX8847Z

## High-Performance Negative Charge Pump for 6 White LEDs in 3mm x 3mm Thin QFN

### Typical Operating Characteristics (continued)

( $V_{IN} = 3.6V$ ,  $V_{EN\_} = V_{IN}$ , circuit of Figure 1,  $T_A = +25^\circ C$ , unless otherwise noted.)

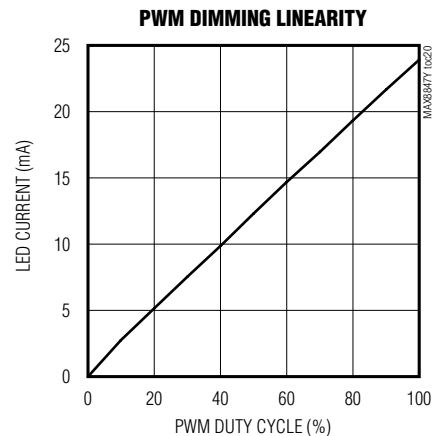
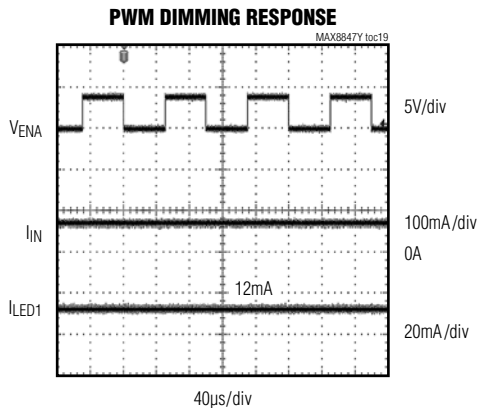
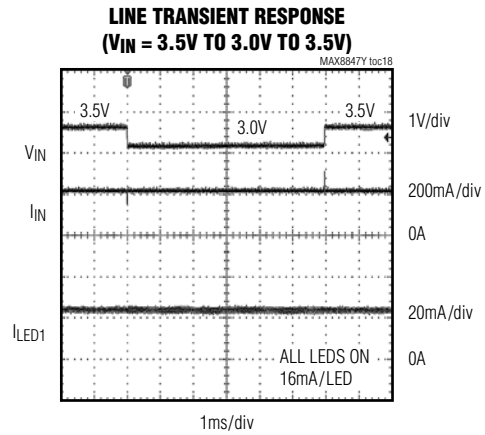
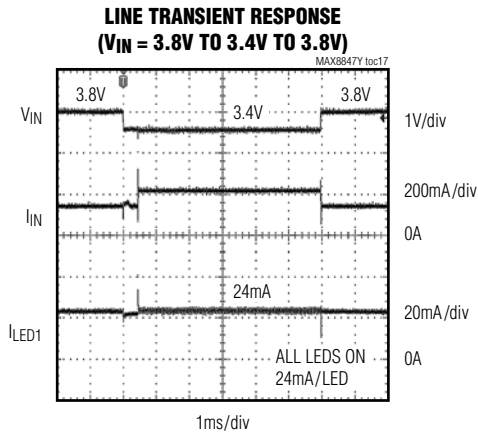
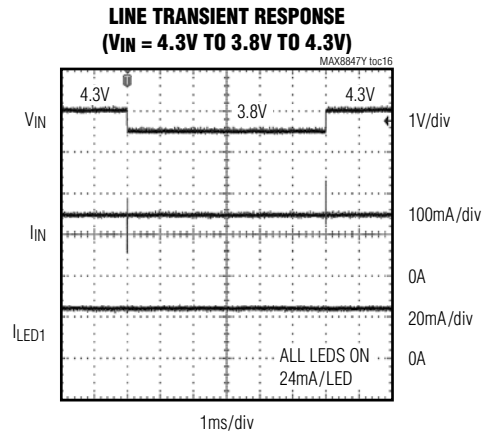
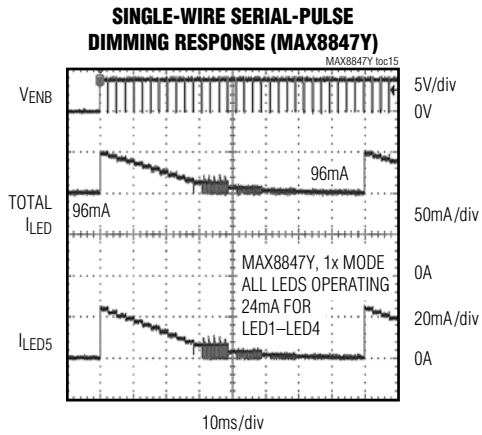

# MAX8847Y/MAX8847Z

## High-Performance Negative Charge Pump for 6 White LEDs in 3mm x 3mm Thin QFN

### Pin Configuration

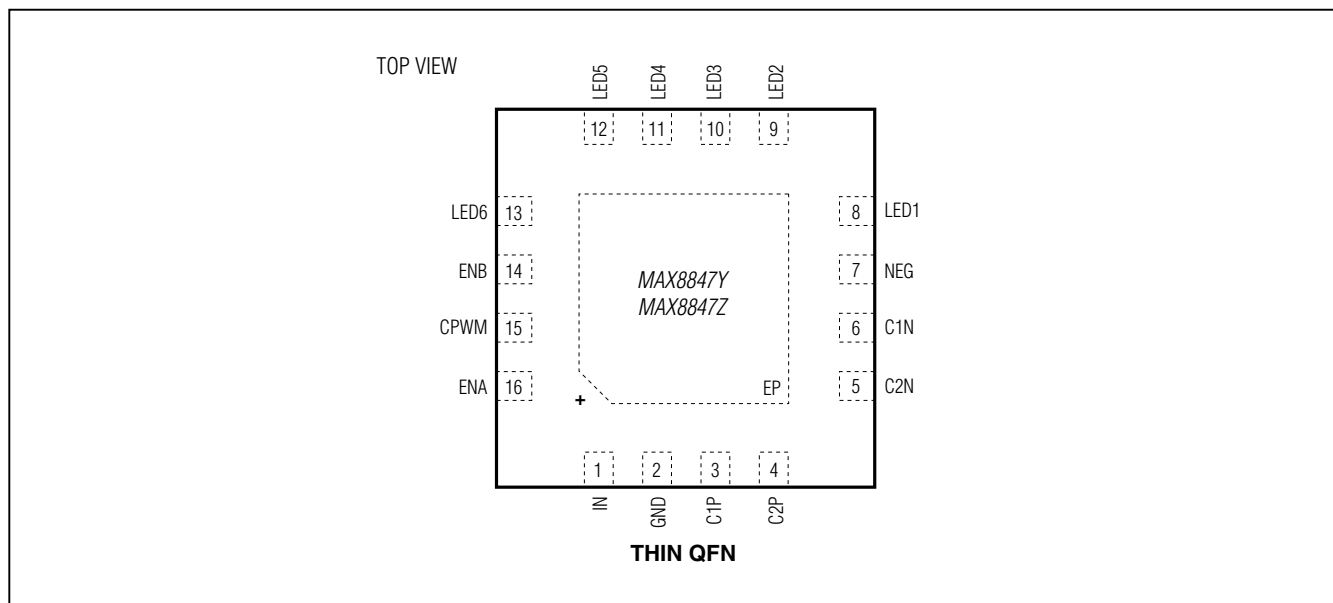

### Pin Description

PIN	NAME	FUNCTION
1	IN	Supply Voltage Input. The input voltage range is 2.7V to 5.5V. Bypass IN to GND with a 1 $\mu$ F ceramic capacitor as close as possible to the IC. IN is high impedance during shutdown. Connect IN to the anodes of all the LEDs.
2	GND	Ground. Connect GND to system ground and the input bypass capacitor as close as possible to the IC.
3	C1P	Transfer Capacitor 1 Positive Connection. Connect a 1 $\mu$ F ceramic capacitor from C1P to C1N.
4	C2P	Transfer Capacitor 2 Positive Connection. Connect a 1 $\mu$ F ceramic capacitor from C2P to C2N.
5	C2N	Transfer Capacitor 2 Negative Connection. Connect a 1 $\mu$ F ceramic capacitor from C2P to C2N. An internal 10k $\Omega$ resistor pulls C2N to GND during shutdown.
6	C1N	Transfer Capacitor 1 Negative Connection. Connect a 1 $\mu$ F ceramic capacitor from C1P to C1N.
7	NEG	Charge-Pump Negative Output. Connect a 1 $\mu$ F ceramic capacitor from NEG to GND. In shutdown, an internal 10k $\Omega$ resistor pulls NEG to GND. Connect the exposed pad to NEG directly under the IC.
8–13	LED1–LED6	LED Current Regulators. Current flowing into LED_ is based on the ENA/ENB input. Connect LED_ to the cathodes of the external LEDs. LED_ is high impedance during shutdown. Short any unused LED_ to IN prior to power-up to disable the corresponding current regulator.
14	ENB	Enable or Serial-Pulse Dimming Control Input B. ENB controls LED5 and LED6. For the MAX8847Z, ENB functions as on/off control for LED5 and LED6. For the MAX8847Y, except on/off control function, ENB can also be used to control the LED5 and LED6 serial-pulse dimming. Drive ENB high to turn on the LED5 and LED6 current regulators at 24mA. Drive ENB low for greater than 8ms to turn off the LED5 and LED6 current regulators or drive both ENA and ENB low to place the IC in shutdown. For the MAX8847Y LED5 and LED6 serial-pulse dimming control, see the <i>Serial-Pulse Dimming Control (MAX8847Y)</i> section for details.

# MAX8847Y/MAX8847Z

## High-Performance Negative Charge Pump for 6 White LEDs in 3mm x 3mm Thin QFN

### Pin Description (continued)

PIN	NAME	FUNCTION
15	CPWM	Filter Capacitor Connection for PWM Dimming. Connect a capacitor from CPWM to GND to form a filter with the internal 360k $\Omega$ resistor. The recommended capacitor for a 2Hz corner frequency is 0.22 $\mu$ F.
16	ENA	Enable or PWM Dimming Control Input A. For the MAX8847Y, ENA functions as on/off control for LED1–LED4 and PWM dimming control for LED1–LED4. For the MAX8847Z, ENA functions as on/off control for LED1–LED4 and PWM dimming control for LED1–LED6. Drive ENA high to turn on the LED1–LED4 current regulators at 24mA each. Drive ENA low for greater than 8ms to turn off the LED1–LED4 current regulators or drive both ENA and ENB low to place the IC in shutdown. Drive ENA with a PWM signal from 200Hz to 200kHz to dim the LEDs. See the <i>PWM Dimming Control</i> section.
—	EP	Exposed Paddle. Connect EP to NEG directly under the IC.

### Detailed Description

The MAX8847Y/MAX8847Z have an inverting charge pump and six current regulators capable of 24mA each to drive up to 6 white LEDs. The current regulators are matched to within 1% (typ) providing uniform white LED brightness for LCD backlight applications. To maximize efficiency, the current regulators operate with as little as 0.15V voltage drop.

Individual white LED current regulators conduct current to GND or NEG to extend usable battery life. In the case of mismatched forward voltage of white LEDs, only the white LEDs requiring higher voltage are switched to pull current to NEG instead of GND, further raising efficiency and reducing battery current drain.

#### Current Regulator Switchover

When  $V_{IN}$  is higher than the LED forward voltage plus the 150mV dropout voltage of the current regulator, the LED current returns through GND. If this condition is satisfied for all active white LEDs, the charge pump remains inactive. When the input voltage drops so that the current regulator voltage ( $V_{LED\_}$ ) cannot be maintained for any of the individual white LEDs, the inverting charge pump activates and generates a voltage on NEG that is

no greater than 5V below  $V_{IN}$ . For any current regulator that is detected at the switchover threshold voltage of 150mV (typ,  $V_{IN}$  falling), internal circuitry switches that current regulator's return path from GND to NEG to provide enough voltage across that regulator to overcome dropout. When  $V_{LED\_}$  rises to 250mV (typ), the return of that current regulator is switched back from NEG to GND. Each current regulator is independently monitored to detect when switchover is required. Since the LED current is switched for only the individual LED current regulators requiring higher voltage, power consumption is minimized.

#### Enable and Dimming Control Input (ENA, ENB)

ENA and ENB inputs have dual functions: LED on/off control and PWM or serial-pulse dimming control. See Table 1 for details. For the MAX8847Y, ENA functions as an on/off control and PWM dimming control for LED1–LED4. ENB functions as on/off control and serial-pulse dimming control for LED5 and LED6. For the MAX8847Z, ENA functions as an on/off control for LED1–LED4 as well as PWM dimming control for LED1–LED6. ENB is used for on/off control for LED5 and LED6.

**Table 1. ENA and ENB Enable and Dimming Control**

PART	ENA	ENB
MAX8847Y	LED1–LED4 enable and PWM dimming control	LED5 and LED6 enable and serial-pulse dimming control
MAX8847Z	LED1–LED4 enable and LED1–LED6 PWM dimming control	LED5 and LED6 enable control



# MAX8847Y/MAX8847Z

## High-Performance Negative Charge Pump for 6 White LEDs in 3mm x 3mm Thin QFN

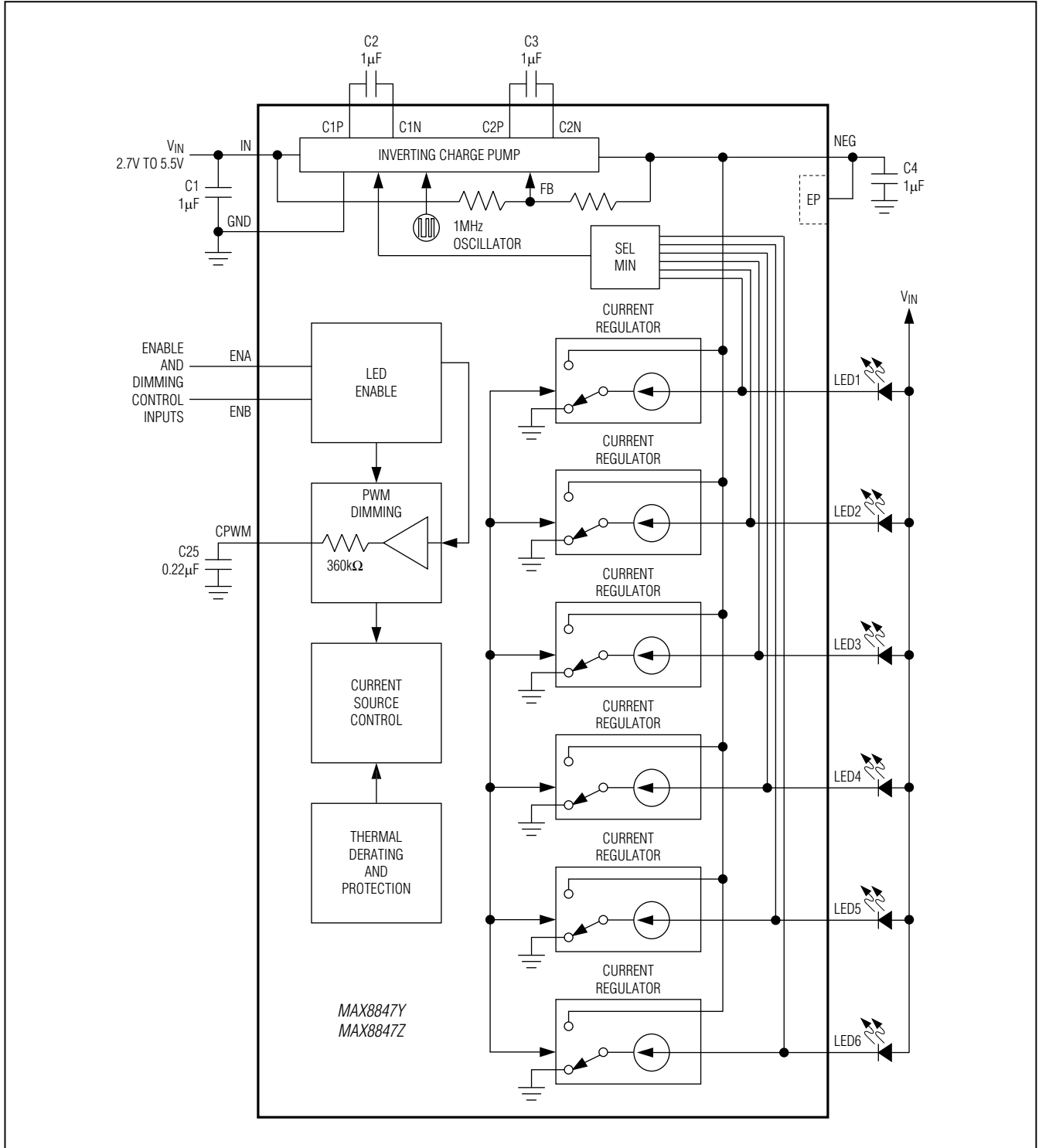

Figure 1. Functional Diagram and Application Circuit

# MAX8847Y/MAX8847Z

## High-Performance Negative Charge Pump for 6 White LEDs in 3mm x 3mm Thin QFN

### PWM Dimming Control

When  $V_{IN}$  is above its undervoltage lockout threshold, UVLO, apply a PWM signal to ENA to set the corresponding WLED current (see Table 1) that is proportional to the signal duty cycle (0% duty cycle corresponds to zero LED current and 100% duty cycle corresponds to full LED current). The allowed PWM frequency range is from 200Hz to 200kHz. If PWM dimming control is not required, ENA works as a simple on/off control.

### Serial-Pulse Dimming Control (MAX8847Y)

The MAX8847Y uses ENB as a serial-pulse control interface to program the intensity of LED5 and LED6. When LED5 and LED6 are enabled by driving ENB high, the

MAX8847Y ramps LED5 and LED6 current to 24mA. Subsequent pulses on ENB reduces the LED5 and LED6 current from 24mA to 0.1mA in 31 steps. After the current reaches 0.1mA, the next pulse restores the current to 24mA. See Table 2 for the LED current values and the corresponding ENB pulse count. Figure 2 shows a timing diagram for ENB.

If dimming control is not required, ENB works as a simple on/off logic control. Drive ENB high for at least 120 $\mu$ s to enable the LED5 and LED6 current regulators, or drive ENB low for greater than 8ms (typ) to place the LED5 and LED6 current regulators in shutdown. The LED current regulators operate at 100% brightness and off under these conditions.

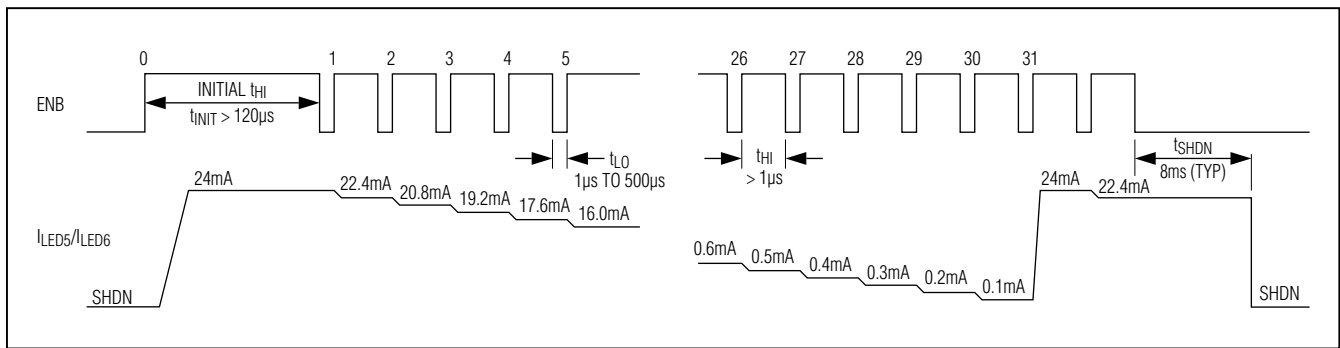

Figure 2. Timing Characteristics for LED Serial-Pulse Dimming Control

Table 2. ENB Serial-Pulse Dimming Count and Programmed LED\_ Currents

ENB PULSE COUNT	PROGRAMMED LED_ CURRENT (mA)	ENB PULSE COUNT	PROGRAMMED LED_ CURRENT (mA)
Startup or ENB high	24.0	16	2.8
1	22.4	17	2.4
2	20.8	18	2.0
3	19.2	19	1.6
4	17.6	20	1.4
5	16.0	21	1.2
6	14.4	22	1.0
7	12.8	23	0.8
8	11.2	24	0.7
9	9.6	25	0.6
10	8.0	26	0.5
11	6.4	27	0.4
12	5.6	28	0.3
13	4.8	29	0.2
14	4.0	30	0.1
15	3.2	31	24.0

# MAX8847Y/MAX8847Z

## High-Performance Negative Charge Pump for 6 White LEDs in 3mm x 3mm Thin QFN

### Low LED Current Levels

The MAX8847Y internally generates a PWM signal to obtain higher resolution at lower currents. See the Single-Wire Serial-Pulse Dimming Response (MAX8847Y) graph in the *Typical Operating Characteristics* section. When the LED current is set below 6.4mA, the IC adjusts not only LED DC current, but the duty cycle that is controlled by the PWM signal. The frequency of the PWM dimming signal is set at 16kHz with a minimum duty cycle of 1/8 to avoid the LED flickering effect to human eyes and also to avoid interference in the audio frequency range. Table 3 shows the current level and the corresponding duty cycle.

### Shutdown Mode

The MAX8847Y/MAX8847Z are in shutdown mode when both ENA and ENB are held low for 8ms or longer. In shutdown, NEG is pulled to GND with a 10k $\Omega$  internal resistor.

### Temperature Derating Function

The MAX8847Y/MAX8847Z contain a derating function that automatically limits the LED current at high temperatures in accordance with the recommended derating curve of popular white LEDs. The derating function enables the safe usage of higher LED current at room temperature, thus reducing the number of LEDs required to backlight the display. The derating circuit lowers the LED current at approximately 2.5%/°C once the die temperature is above +60°C. The typical derating function characteristic is shown in the *Typical Operating Characteristics*.

**Table 3. Internal PWM Duty Cycle vs. LED Set Current**

I <sub>LED</sub> (mA)	MAXIMUM I <sub>LED</sub> (mA)*	DUTY CYCLE (n/8)	I <sub>LED</sub> (mA)	MAXIMUM I <sub>LED</sub> (mA)*	DUTY CYCLE (n/8)
6.4	6.4	8	1.2	1.6	6
5.6	6.4	7	1.0	1.6	5
4.8	6.4	6	0.8	0.8	8
4.0	6.4	5	0.7	0.8	7
3.2	3.2	8	0.6	0.8	6
2.8	3.2	7	0.5	0.8	5
2.4	3.2	6	0.4	0.8	4
2.0	3.2	5	0.3	0.8	3
1.6	1.6	8	0.2	0.8	2
1.4	1.6	7	0.1	0.8	1

\*Maximum I<sub>LED</sub> is the full reference current when the internal PWM signal has 100% duty cycle at the lower level currents.

### Power-Up LED Short Detection and Open-Fault Protection

The MAX8847Y/MAX8847Z contain special circuitry to detect short-circuit conditions at power-up and disable the corresponding current regulator to avoid wasting battery current. Connect any unused LED<sub>n</sub> to IN to disable the corresponding current regulator. If an LED fails short-circuit detection after startup, the current regulator continues the current regulated operation until IC power is cycled and the short circuit is detected during the subsequent startup.

An open-circuit LED failure drives the voltage on the corresponding LED current regulator output below the switchover threshold, enabling the negative charge pump.

### Thermal Shutdown

The MAX8847Y/MAX8847Z include a thermal-limit circuit that shuts down the IC above approximately +160°C. The IC turns on after it cools by approximately 20°C.

## Applications Information

### Input Ripple

For LED drivers, input ripple is more important than output ripple. The amount of input ripple depends on the source supply's output impedance. Add a lowpass filter to the input of the MAX8847Y/MAX8847Z to further reduce input ripple. Alternatively, increasing C<sub>IN</sub> from 1.0 $\mu$ F to 2.2 $\mu$ F (or 4.7 $\mu$ F) cuts input ripple in half (or in fourth) with only a small increase in footprint.

### Capacitor Selection

Ceramic capacitors are recommended due to their small size, low cost, and low ESR. Select ceramic capacitors that maintain their capacitance over temperature and DC bias. Capacitors with X5R or X7R temperature characteristics generally perform well. Recommended values are shown in the *Typical Operating Circuit*. Using a larger value input capacitor helps to reduce input ripple (see the *Input Ripple* section).

### PCB Layout and Routing

The MAX8847Y/MAX8847Z are high-frequency switched-capacitor voltage inverters. For best circuit performance, use a solid ground plane and place all capacitors as close as possible to the IC. Use large traces for the power-supply inputs to minimize losses due to parasitic trace resistance and to route heat away from the device. Refer to the MAX8848Z evaluation kit data sheet for an example PCB layout.

# MAX8847Y/MAX8847Z

## High-Performance Negative Charge Pump for 6 White LEDs in 3mm x 3mm Thin QFN

### Chip Information

PROCESS: BiCMOS

### Package Information

For the latest package outline information and land patterns, go to [www.maximintegrated.com/packages](http://www.maximintegrated.com/packages). Note that a "+", "#", or "-" in the package code indicates RoHS status only. Package drawings may show a different suffix character, but the drawing pertains to the package regardless of RoHS status.

PACKAGE TYPE	PACKAGE CODE	DOCUMENT NO.
16 Thin QFN-EP	T1633+5	<a href="#">21-0136</a>

# MAX8847Y/MAX8847Z

## High-Performance Negative Charge Pump for 6 White LEDs in 3mm x 3mm Thin QFN

### Revision History

REVISION NUMBER	REVISION DATE	DESCRIPTION	PAGES CHANGED
0	4/10	Initial release	—



Maxim Integrated cannot assume responsibility for use of any circuitry other than circuitry entirely embodied in a Maxim Integrated product. No circuit patent licenses are implied. Maxim Integrated reserves the right to change the circuitry and specifications without notice at any time. The parametric values (min and max limits) shown in the Electrical Characteristics table are guaranteed. Other parametric values quoted in this data sheet are provided for guidance.

**Maxim Integrated 160 Rio Robles, San Jose, CA 95134 USA 1-408-601-1000**

**13**