



STPS60150C

POWER SCHOTTKY RECTIFIER

Table 1: Main Product Characteristics

$I_{F(AV)}$	2 x 30 A
V_{RRM}	150 V
T_j	175°C
$V_F(max)$	0.76 V

FEATURES AND BENEFITS

- High junction temperature capability
- Low leakage current
- Low thermal resistance
- High frequency operation
- Avalanche specification

DESCRIPTION

Dual center tab Schottky rectifier suited for High Frequency server and telecom base station SMPS. Packaged in TO-220AB, this device combines high current rating and low volume to enhance both reliability and power density of the application.

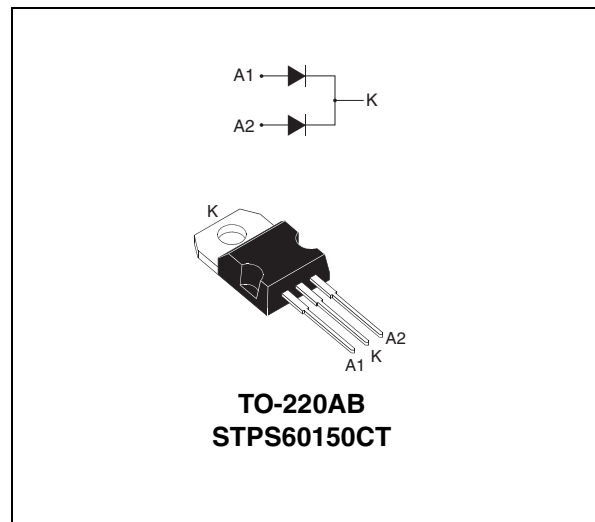

Table 2: Order Codes

Part Number	Marking
STPS60150CT	STPS60150CT

Table 3: Absolute Ratings (limiting values, per diode)

Symbol	Parameter	Value	Unit
V_{RRM}	Repetitive peak reverse voltage	150	V
$I_{F(RMS)}$	RMS forward voltage	60	A
$I_{F(AV)}$	Average forward current $T_c = 150^\circ\text{C}$ $\delta = 0.5$	Per diode 60	A
I_{FSM}	Surge non repetitive forward current	$t_p = 10\text{ms}$ sinusoidal	270 A
P_{ARM}	Repetitive peak avalanche power	$t_p = 1\mu\text{s}$ $T_j = 25^\circ\text{C}$	17300 W
T_{stg}	Storage temperature range	-65 to + 175	°C
T_j	Maximum operating junction temperature *	175	°C
dV/dt	Critical rate of rise of reverse voltage	10000	V/ μs

*: $\frac{dP_{tot}}{dT_j} > \frac{1}{R_{th(j-a)}}$ thermal runaway condition for a diode on its own heatsink

STPS60150C

Table 4: Thermal Parameters

Symbol	Parameter		Value	Unit
$R_{th(j-c)}$	Junction to case	Per diode	1.0	$^{\circ}\text{C}/\text{W}$
		Total	0.7	
$R_{th(c)}$	Coupling		0.4	

When the diodes 1 and 2 are used simultaneously:

$$\Delta T_j(\text{diode 1}) = P(\text{diode 1}) \times R_{th(j-c)}(\text{Per diode}) + P(\text{diode 2}) \times R_{th(c)}$$

Table 5: Static Electrical Characteristics (per diode)

Symbol	Parameter	Tests conditions		Min.	Typ	Max.	Unit
I_R^*	Reverse leakage current	$T_j = 25^{\circ}\text{C}$	$V_R = V_{RRM}$		3	15	μA
		$T_j = 125^{\circ}\text{C}$			3	10	mA
V_F^{**}	Forward voltage drop	$T_j = 25^{\circ}\text{C}$	$I_F = 30\text{A}$			0.94	V
		$T_j = 125^{\circ}\text{C}$	$I_F = 30\text{A}$		0.72	0.76	
		$T_j = 25^{\circ}\text{C}$	$I_F = 60\text{A}$		0.97	1.05	
		$T_j = 125^{\circ}\text{C}$	$I_F = 60\text{A}$		0.86	0.92	

Pulse test: * $t_p = 5 \text{ ms}$, $\delta < 2\%$

** $t_p = 380 \mu\text{s}$, $\delta < 2\%$

To evaluate the conduction losses use the following equation: $P = 0.6 \times I_{F(AV)} + 0.0053 I_{F(RMS)}^2$

Figure 1: Average forward power dissipation versus average forward current (per diode)

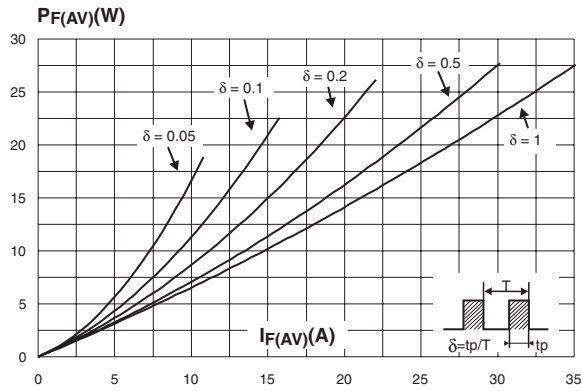

Figure 2: Average forward current versus ambient temperature ($\delta = 0.5$, per diode)

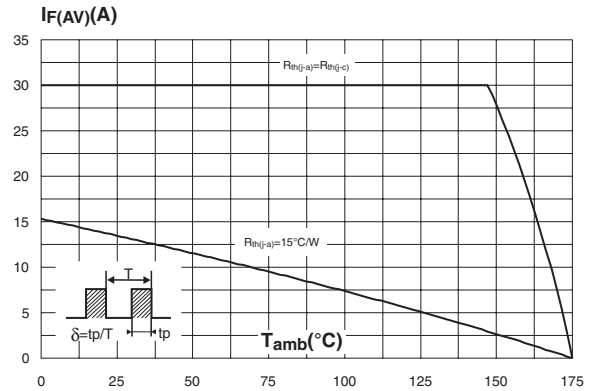

Figure 3: Normalized avalanche power derating versus pulse duration

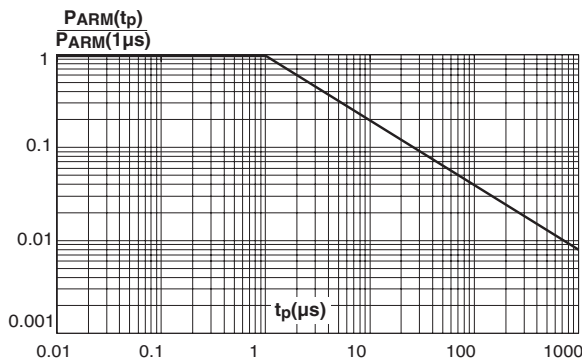

Figure 4: Normalized avalanche power derating versus junction temperature

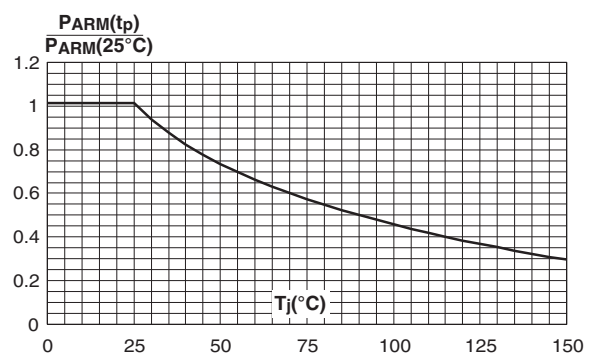

Figure 5: Non repetitive surge peak forward current versus overload duration (maximum values, per diode)

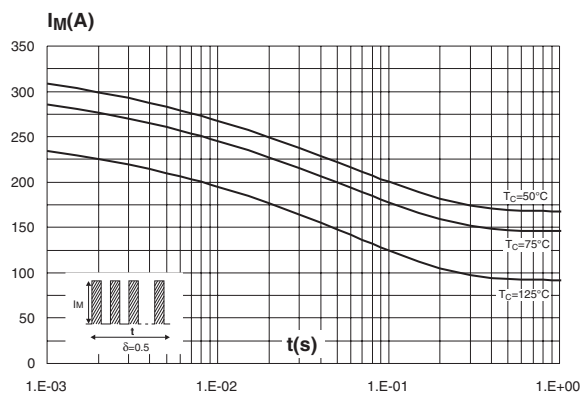

Figure 6: Relative variation of thermal impedance junction to case versus pulse duration (per diode)

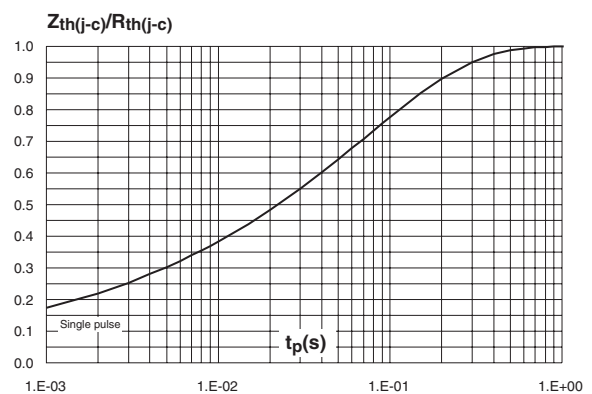

Figure 7: Reverse leakage current versus reverse voltage applied (typical values, per diode)

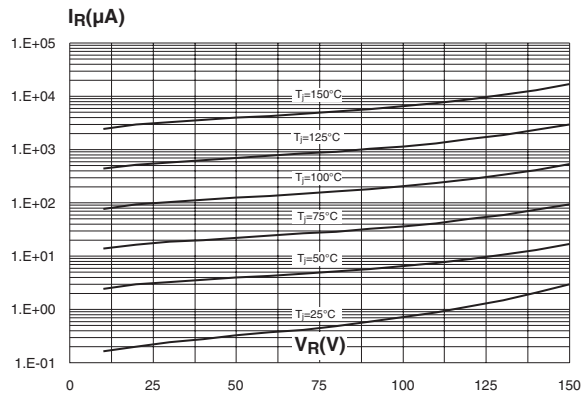

Figure 8: Junction capacitance versus reverse voltage applied (typical values, per diode)

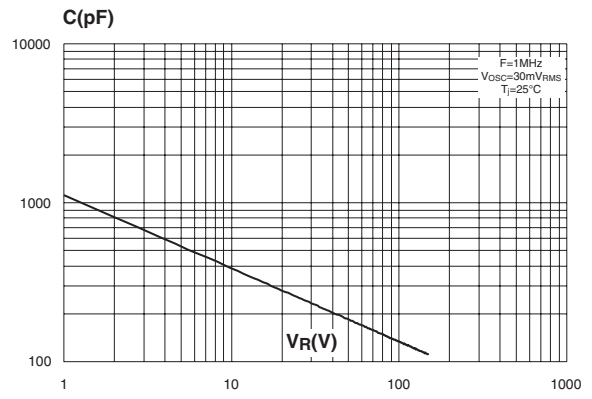

Figure 9: Forward voltage drop versus forward current (per diode)

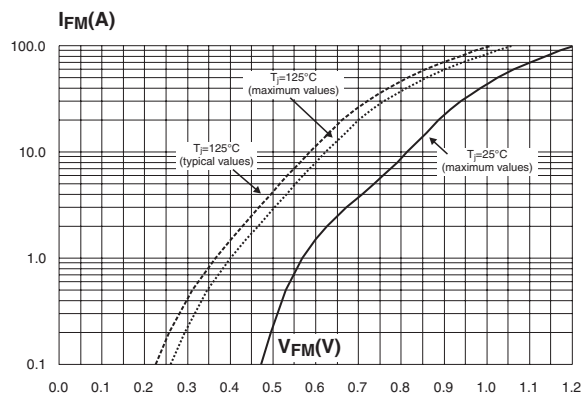

Figure 10: TO-220AB Package Mechanical Data

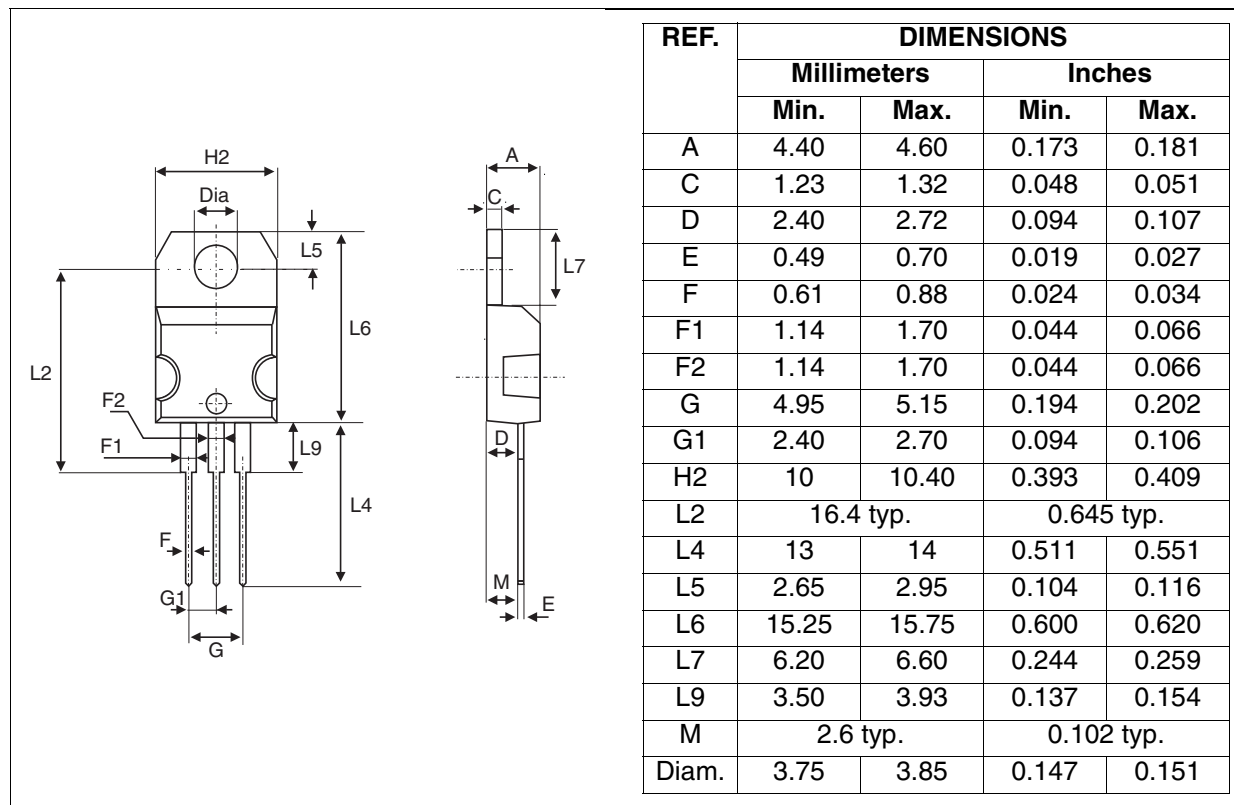

Table 6: Ordering Information

Ordering type	Marking	Package	Weight	Base qty	Delivery mode
STPS60150CT	STPS60150CT	TO-220AB	2.20 g	50	Tube

- Epoxy meets UL94, V0
- Cooling method: by conduction (C)
- Recommended torque value: 0.8 m.N.
- Maximum torque value: 1.0 m.N.

Table 7: Revision History

Date	Revision	Description of Changes
19-Oct-2004	1	First issue.

Information furnished is believed to be accurate and reliable. However, STMicroelectronics assumes no responsibility for the consequences of use of such information nor for any infringement of patents or other rights of third parties which may result from its use. No license is granted by implication or otherwise under any patent or patent rights of STMicroelectronics. Specifications mentioned in this publication are subject to change without notice. This publication supersedes and replaces all information previously supplied. STMicroelectronics products are not authorized for use as critical components in life support devices or systems without express written approval of STMicroelectronics.

The ST logo is a registered trademark of STMicroelectronics.
All other names are the property of their respective owners

© 2004 STMicroelectronics - All rights reserved

STMicroelectronics group of companies

Australia - Belgium - Brazil - Canada - China - Czech Republic - Finland - France - Germany - Hong Kong - India - Israel - Italy - Japan -
Malaysia - Malta - Morocco - Singapore - Spain - Sweden - Switzerland - United Kingdom - United States of America
www.st.com