

Preliminary

TOSHIBA Photo IC Silicon Epitaxial Planar

TPS820

Photo-Electric Switches
Copiers, Printers, and Facsimiles
Luminosity Adjustment for Various
Types of Equipment

Unit: mm

The TPS820 is a linear output photo-IC (current output type) which incorporates a photodiode and a current amp circuit in a single chip.

The sensitivity is superior to that of a phototransistor and its illuminance output linearity is excellent.

- High sensitivity: $I_L = 2.5 \text{ mA (typ.) @ } E = 0.1 \text{ mW/cm}^2$
- Little fluctuation in light current
- Output linearity of illuminance is excellent.
- Low current consumption: $I_{CC} = 1 \text{ } \mu\text{A (max) at } V_{CC} = 5 \text{ V}$
- Housed in compact side-view epoxy resin package
- Black package impermeable to visible light
- The TPS820 is suitable for use in combination with the TLN117 infrared LED lamp whose package size is the same.

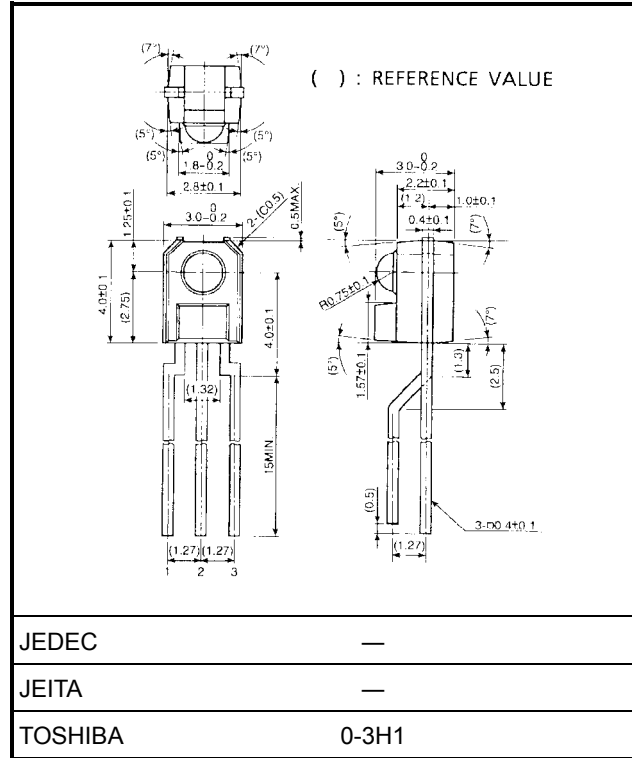

Weight: 0.12 g (typ.)

Maximum Ratings (Ta = 25°C)

Characteristics	Symbol	Rating	Unit
Supply voltage	V_{CC}	-0.5~7	V
Output voltage	V_O	$\leq V_{CC}$	V
Light current	I_L	10	mA
Power dissipation	P	250	mW
Power dissipation derating	$\Delta P/^\circ\text{C}$	-3.33	mW/°C
Operating temperature range	T_{opr}	-25~85	°C
Storage temperature range	T_{stg}	-40~100	°C
Soldering temperature (5 s) (Note1)	T_{sol}	260	°C

Note 1: At the location of 1.3 mm from the resin package bottom

Pin Configuration

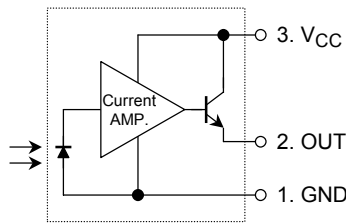

Optical and Electrical Characteristics (Ta = 25°C, VCC = 5 V)

Characteristics	Symbol	Test Condition	Min	Typ.	Max	Unit
Current consumption	I_{CC}	$E = 0$, I_L must be open between pins	—	0.017	1	μA
Light current (1)	$I_L(1)$	$E = 0.01 \text{ mW/cm}^2$ (Note2)	100	250	400	μA
Light current (2)	$I_L(2)$	$E = 0.1 \text{ mW/cm}^2$ (Note2)	1	2.5	4	mA
Output linearity	$I_L(2)/I_L(1)$	—	8	10	12	—
Saturation output voltage	$V_{OUT(sat)}$	$E = 0.1 \text{ mW/cm}^2$ (Note2) $R_L = 10 \text{ k}\Omega$	4.1	4.2	—	V
Dark current	I_D	$E = 0$	—	—	0.5	μA
Peak sensitivity wavelength	λ_p	—	—	870	—	nm
Rise time	t_r	$V_{OUT} = 2.5 \text{ V}$	—	250	—	μs
Fall time	t_f	$R_L = 10 \text{ k}\Omega$ (Note3)	—	700	—	μs

Note 2: The light used is a CIE standard A light source (a standard tungsten bulb with a color temperature of 2856K)

Note 3: Switching time measurement circuit and waveform

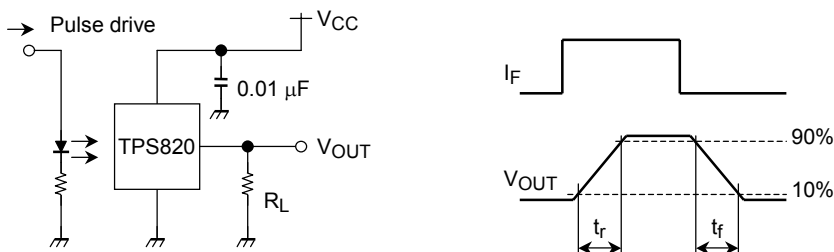

Precautions

- When this device is used in combination with an LED lamp, the lamp must be an infrared LED lamp.
- To stabilize the power line, insert a bypass capacitor of up to 0.01 μF between VCC and GND, close to the device.
- When the power is turned on, the output value will fluctuate for 1 ms as the internal circuit stabilizes.

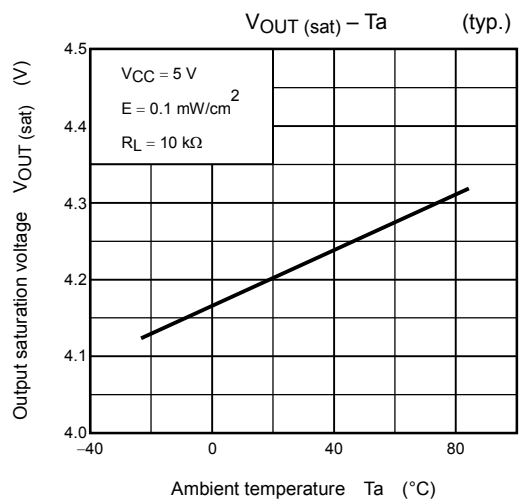
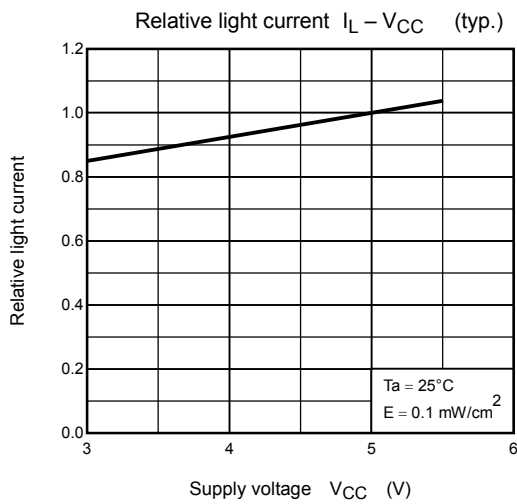
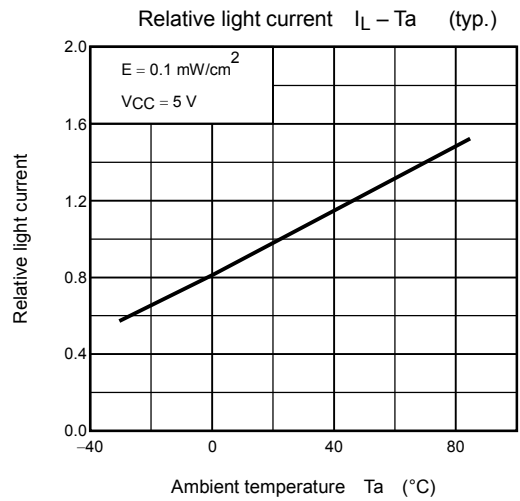
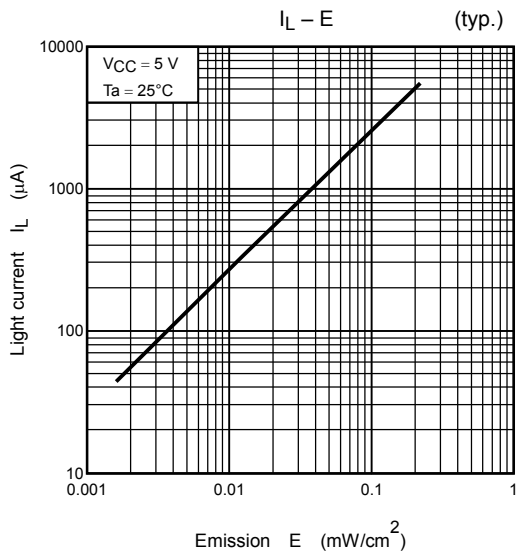
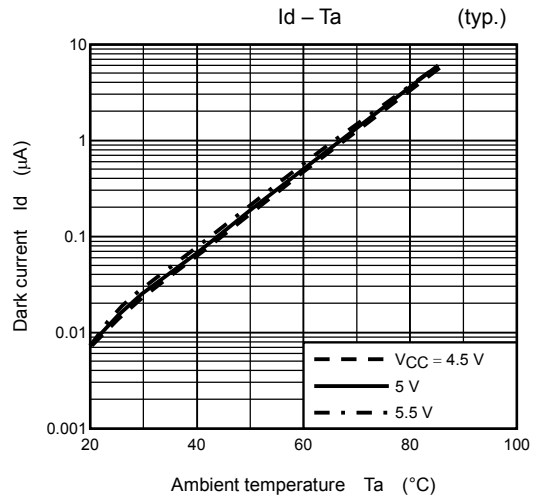
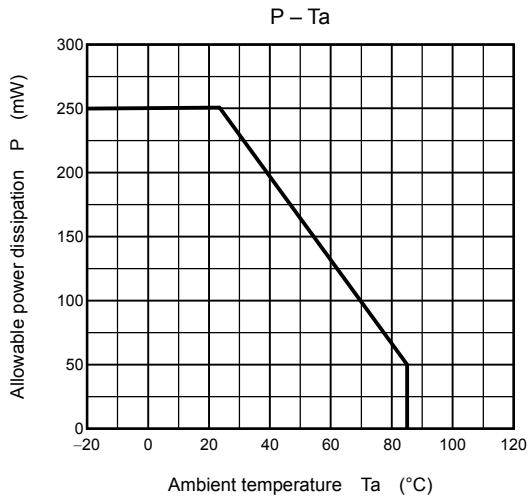

Switching characteristics (no saturation) (typ.)

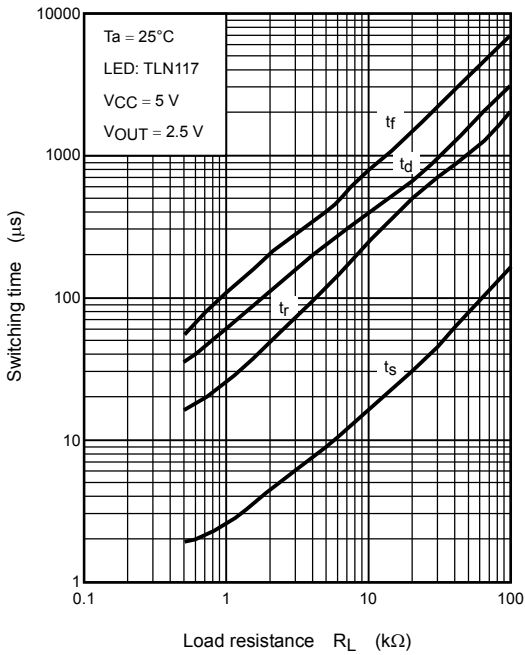

Switching characteristics (saturation) (typ.)

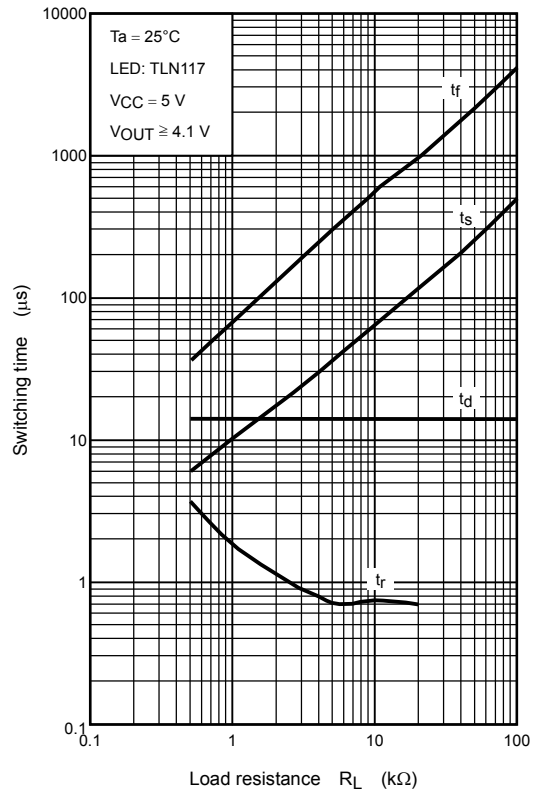

Switching time measurement circuit and waveform

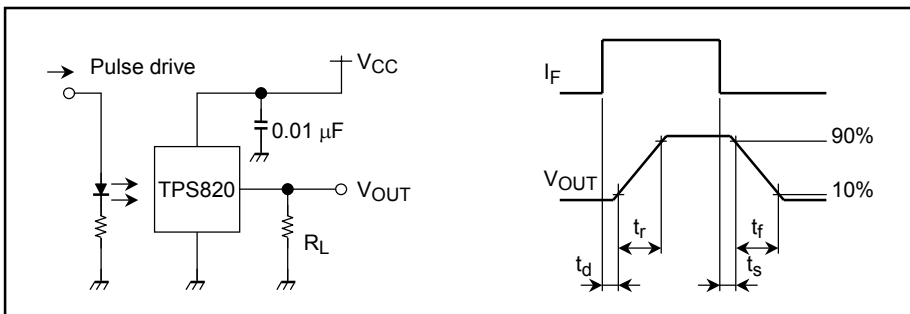

Spectral response (typ.)

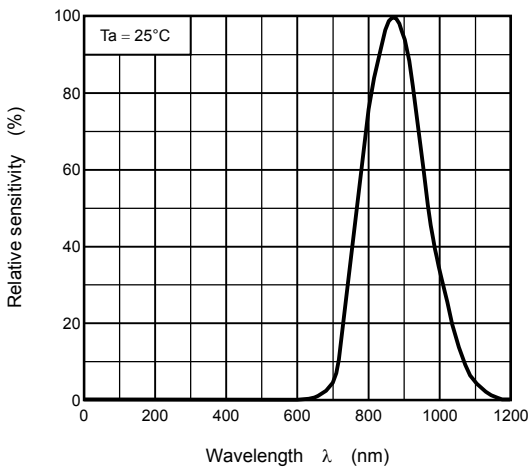

Radiation pattern (typ.)

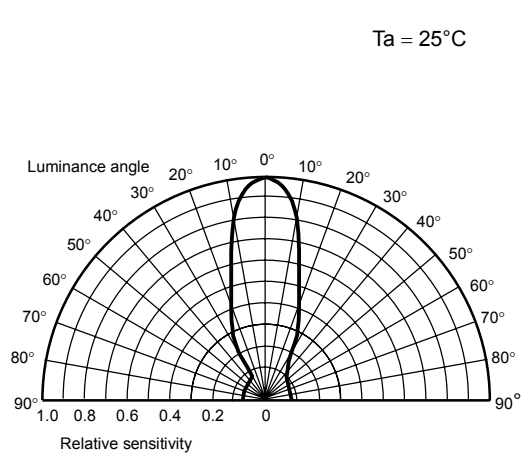

RESTRICTIONS ON PRODUCT USE

000707EAA

- TOSHIBA is continually working to improve the quality and reliability of its products. Nevertheless, semiconductor devices in general can malfunction or fail due to their inherent electrical sensitivity and vulnerability to physical stress. It is the responsibility of the buyer, when utilizing TOSHIBA products, to comply with the standards of safety in making a safe design for the entire system, and to avoid situations in which a malfunction or failure of such TOSHIBA products could cause loss of human life, bodily injury or damage to property.
In developing your designs, please ensure that TOSHIBA products are used within specified operating ranges as set forth in the most recent TOSHIBA products specifications. Also, please keep in mind the precautions and conditions set forth in the "Handling Guide for Semiconductor Devices," or "TOSHIBA Semiconductor Reliability Handbook" etc..
- The TOSHIBA products listed in this document are intended for usage in general electronics applications (computer, personal equipment, office equipment, measuring equipment, industrial robotics, domestic appliances, etc.). These TOSHIBA products are neither intended nor warranted for usage in equipment that requires extraordinarily high quality and/or reliability or a malfunction or failure of which may cause loss of human life or bodily injury ("Unintended Usage"). Unintended Usage include atomic energy control instruments, airplane or spaceship instruments, transportation instruments, traffic signal instruments, combustion control instruments, medical instruments, all types of safety devices, etc.. Unintended Usage of TOSHIBA products listed in this document shall be made at the customer's own risk.
- The information contained herein is presented only as a guide for the applications of our products. No responsibility is assumed by TOSHIBA CORPORATION for any infringements of intellectual property or other rights of the third parties which may result from its use. No license is granted by implication or otherwise under any intellectual property or other rights of TOSHIBA CORPORATION or others.
- The information contained herein is subject to change without notice.